

# Awning Window

COMMERCIAL SERIES - 125mm FRAME

## PRODUCT SPECIFICATION SHEET



Rylock Awning Windows feature heavy duty extrusions, to deliver large sash openings which maximise your view and promote natural air-flow, for a comfortable living environment.

Rylock Commercial Series Awning Windows offer exceptional strength and durability. The (openable) sash is controlled by stainless steel stays (or Hook Hinges for short and wide sashes), which comfortably support its weight, drawing it in tightly when closed. Dual sash seals and adjustable snubbers ensure resistance against air and water infiltration for exceptional results in AS 2047 Windows and External Glazed Doors compliance testing.

Awning Windows are glazed in accordance with AS 1288 Glass in Buildings and whilst a large range of options are available, all products are glazed with Grade A Safety Toughened Low-e Double Glazing (Argon Fill) as a standard specification.

Determined by the product's size and configuration, a large range of hardware options are available, including Truth™ Bar Operator and Chainwinder (both key lockable) and Electric Operators (single and double motor). Extruded flyscreens are fitted as a standard inclusion, and products are powder coated in-house from a selection of 30 standard colours and textures; and tested by the CSIRO for durability.

Rylock manufacture products designed to meet your particular site conditions and any existing requirements, to achieve the best results. Speak with a Rylock Sales Consultant about your home or next project to achieve a custom, high performance solution.

### TECHNICAL SPECIFICATIONS

Max Product Height	6000mm
Max Product Width	6000mm
Max Sash Height	3050mm <sup>(1)</sup>
Max Sash Width	2750mm <sup>(1)</sup>

---

Glazing Capacity	4mm - 24.76mm
------------------	---------------

---

---

Wind Rating	N1 - N3
-------------	---------

---

Air Infiltration	0.1 L/s.m <sup>2</sup>
------------------	------------------------

Water Resistance	600 Pa
------------------	--------

<sup>(1)</sup> Sash height and width are relative measures, and must comply with maximum area and mass limitations (on page 7).

### ENERGY PERFORMANCE

U <sub>w</sub> Value	2.7 <sup>(2)</sup>
----------------------	--------------------

SHGC <sub>w</sub> Range	0.21 - 0.48 <sup>(2)</sup>
-------------------------	----------------------------

<sup>(2)</sup> Energy results are product and size specific. As product sizes reduce, energy values increase. Custom energy results will be supplied with your Quotation - Sales Order.

# Awning Window

COMMERCIAL SERIES - 125mm FRAME

Rylock Commercial Series Awning Windows are endlessly customisable, offering stunning architectural designs and many outstanding features:



**Stainless Steel Stays** control sash movement and **Dual Sash Seals** minimise water and air infiltration.



**Hook Hinges** replace Stainless Steel Stays for sash heights up to 750mm and widths up to 2750mm.

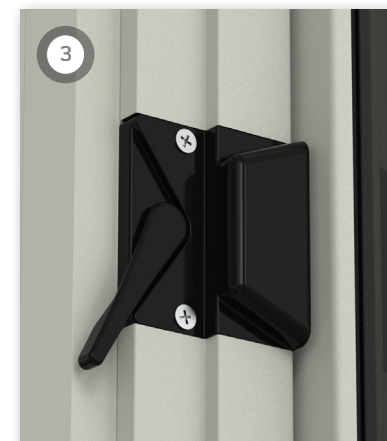

**Latches** are fitted to each side of the sash to draw it in tightly against the **Dual Sash Seals**.

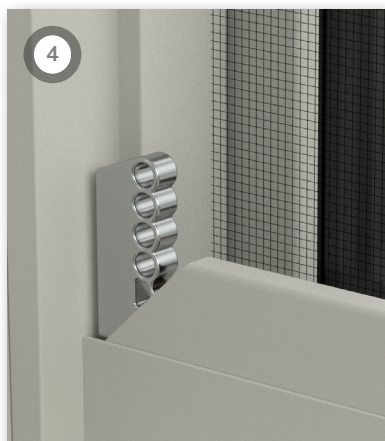

Standard inclusion **Extruded Flyscreens** with various mesh options feature a hidden **Corner Stake**.



IGU standard specification is Grade A Safety Toughened Low-e Double Glazing (Argon Fill).

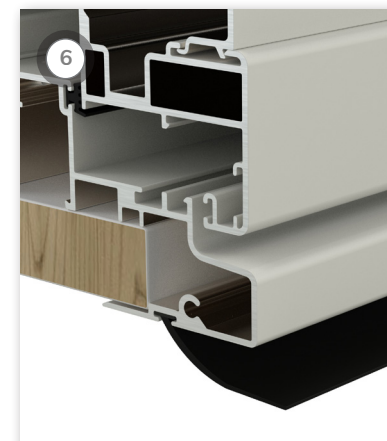

Optional **Sill Flap** expels water from the building for Brick Veneer and Double Brick applications.

 NOISE SOLUTION

 SECURITY SOLUTION

 BUSHFIRE SOLUTION

## PRODUCT FEATURES

Powder coat frame and hardware colours displayed for visual contrast purposes only.

# Awning Window

## COMMERCIAL SERIES - 125mm FRAME

Awning Windows are ideal for living areas, bedrooms, bathrooms and highlight window applications to promote ventilation and light. Dependant on the product size and usage, your Sales Consultant can guide you on the most appropriate solution of three hardware options.

For unrivaled ease of operation the **Truth™ Bar Operator** features a superior dual arm scissor action (below) with key lock. **Chainwinders** are good for smaller sash sizes and also feature key locking, with both operators recessed neatly into the product to minimise obstruction of window furnishings. These hardware options are available in three colours: black, white and silver.

Highlight Awning Windows promote cross-flow ventilation with an **Electric Operator (Single or Double Motor)** with concealed housing, extrusions match the product frame and are powder coated in-house, in one of Rylock's 30 standard colours and textures.



Truth™ Bar Operator with Dual Arm Scissor Action and Latches

## HARDWARE OPTIONS

*Powder coat frame and hardware colours displayed for visual contrast purposes only.*



Truth™ Bar Operator



Chainwinder

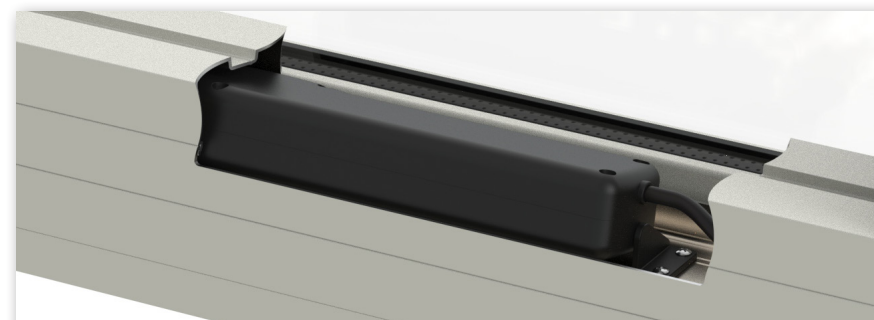

Electric Operator (Single or Double Motor) with concealed housing

# Awning Window

COMMERCIAL SERIES - 125mm FRAME

A product's reveal type and depth can be customised to suit various building materials, to achieve a particular architectural style and deliver ultimate customisation.



Example of Plaster Reveal Offset application

## REVEAL TYPE & DEPTH

Powder coat frame and hardware colours displayed for visual contrast purposes only.



### Primed Timber Reveal

A pre-primed in-line timber reveal for ease of installation is ready for painting. Architrave supplied by others.



### Hardwood Reveal

Select grade hardwood in-line timber reveal for ease of installation is ready to varnish. Architrave supplied by others.



### Plaster Reveal Offset

Common in modern housing construction (pictured left) products are fitted with a 1.6mm spacer to aid installation of the EzyReveal™ system.



### Reveal Equaliser

A versatile solution which provides a powder coated finish to the full height of the internal surface of the frame with concealed fixing pocket.

# Awning Window

COMMERCIAL SERIES - 125mm FRAME

# TECHNICAL RESOURCES



V25.1

# Awning Window

## COMMERCIAL SERIES - 125mm FRAME

## SIZING & CONFIGURATIONS

Given the custom nature of Rylock Commercial Series Awning Windows, product configurations are virtually limitless, provided compliance with Australian Standards is met. Pages 7 and 8 of this technical resource detail Rylock's sizing matrices for Awning sashes and Fixed Lite panels which comply with NCC requirements and hardware operator specifications. These resources are best used in consultation with your Rylock Sales Consultant or alongside Rylock's Revit Library, which features in-built sizing limitations.

This example diagram (right), highlights the relationship between sizing and configurations of Awning sashes and Fixed Lite panels, within the overall frame of an Awning Window. Sashes have important sizing limitations based on mass, and the selected hardware operator's specifications. Integral structural members are used to split glazed portions of an overall frame to assign panels as an Awning sash area or Fixed Lite panel area.

**Note: Overall frame width and height cannot exceed 6000mm.**

Awning sash parameters, (shown in blue), detail the height, width and area limitations that correspond to sash mass. This determines which hardware operator options are available for a given sash size. **Refer to page 7 for the Awning Sash Sizing Matrix.** Fixed Lite parameters, (in this diagram show in grey), detail the size limitations that correspond to maximum panel area. **Refer to page 8 for the Fixed Lite Sizing Matrix.**

**Note: Dimension 1 and dimension 2 on the sizing matrix are interchangeable providing product is within maximum areas specified.**

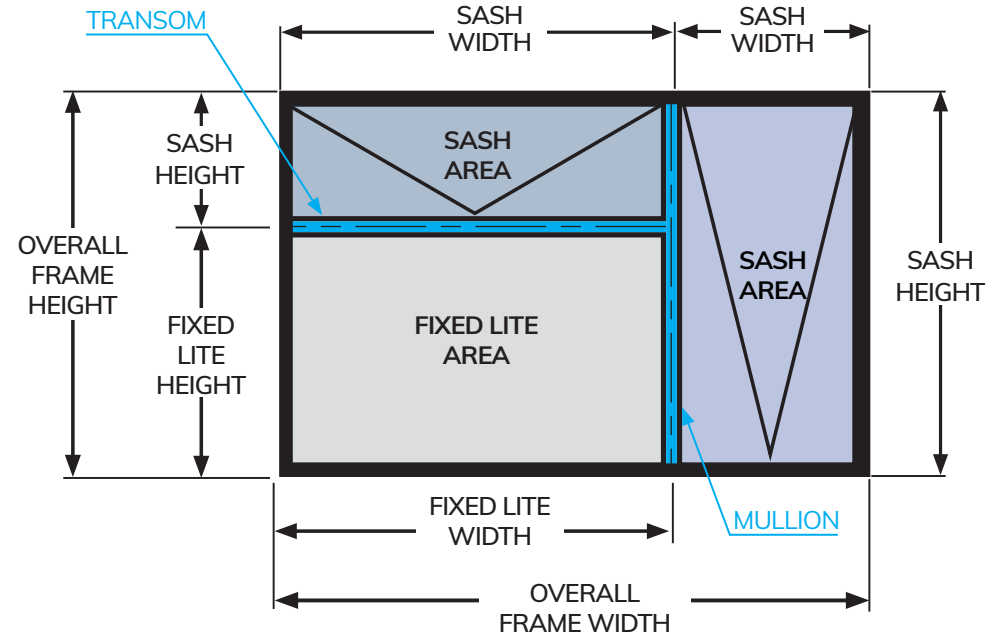

Rylock's Commercial Series Revit Library offers a comprehensive family of product configurations for integration into your next project. Parametric modelling aids the specification of Rylock product, with a content library that is comprised of 8 primary product ranges, with 64 separate families that represent a wide range of overall size and configuration options.

Designers and Architects can download the Revit virtual showroom, product library and user guide at our website: [www.rylock.com.au/resources/specify](http://www.rylock.com.au/resources/specify)

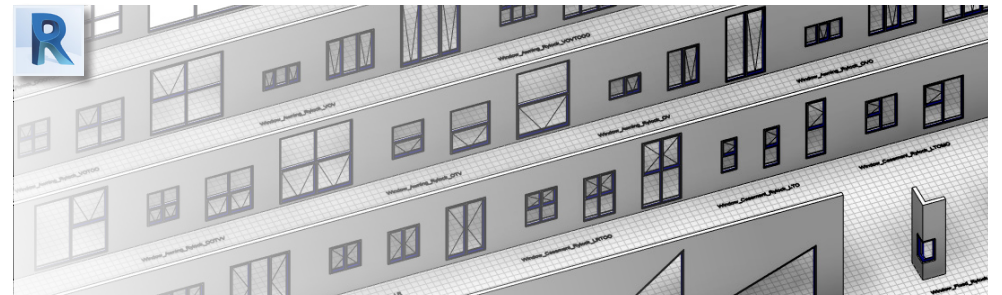



# Awning Window

COMMERCIAL SERIES - 125mm FRAME

# FIXED LITE SIZING MATRIX

These technical resources are best used in consultation with your Rylock Sales Consultant.

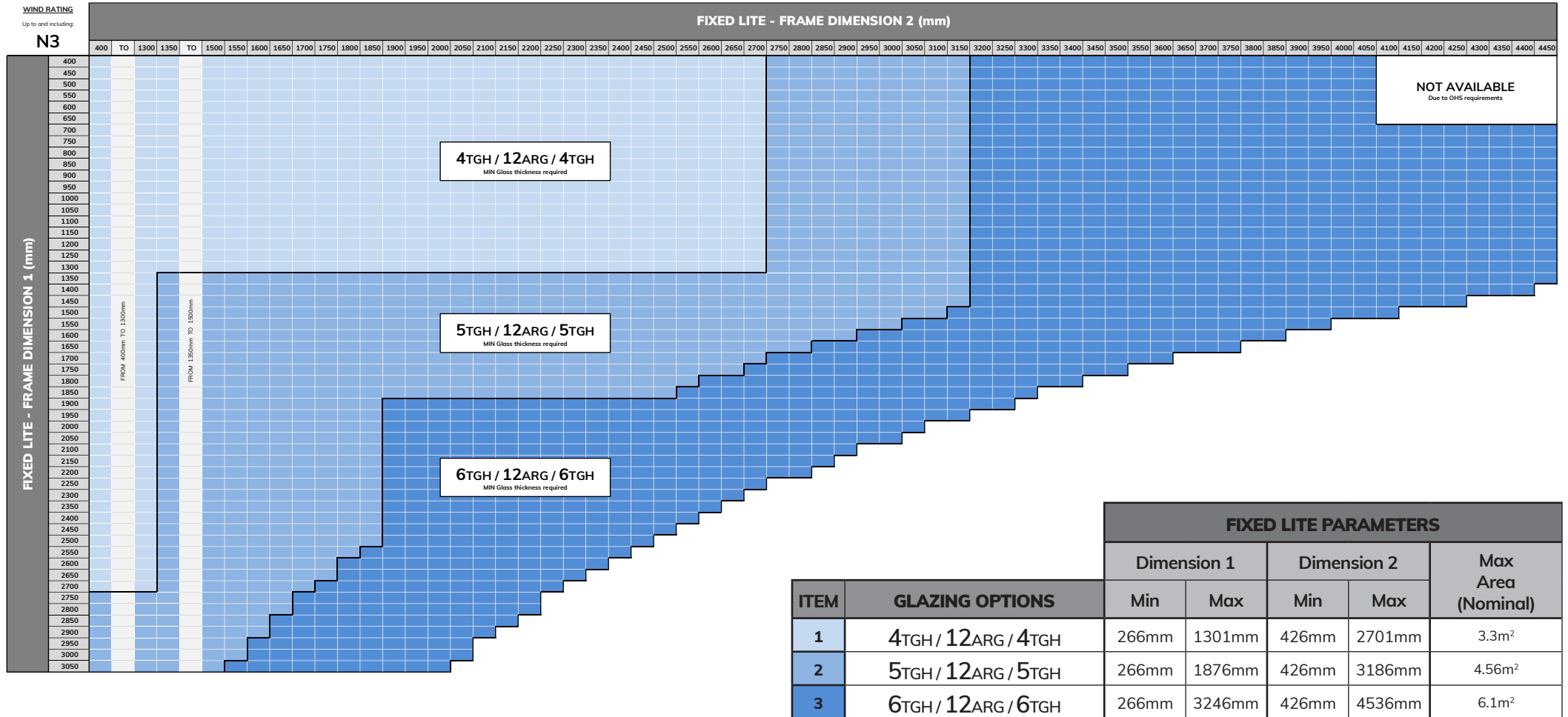

**Notes:**

- This matrix is based on frame sizes using Rylock's default Comfort Solution Glazing: High Performance Low-e DG IGU.
- Other glazings are available with various sizing limitations, discuss options with your Rylock Sales Consultant.
- The shaded regions display the minimum required glass thickness for compliance with human impact and N1 - N3 wind rating.
- Frame Dimension 1 and Frame Dimension 2 can be interchanged with respect to the height and width of Fixed Lite.
- All sizes are based on outer frame dimensions (not glass dimensions).
- TGH means Toughened Glass (Grade A Safety).
- ARG means Argon Gas (Inert gas used in IGUs for energy efficiency).

# Awning Window

COMMERCIAL SERIES - 125mm FRAME

## INSTALLATION RESOURCES

These technical resources are best used in consultation with your Rylock Sales Consultant.



Rylock has extensive resources to support customers in the best practice application of its products. Our extensive online library has technical resources including product x-section drawings in PDF and DWG format, typical building-in installation detail with 3D interactive renders, as well as operation and adjustment videos.

The most vital aspect of correct function is correct installation and it is recommended that the manufacturer's specification is always followed as improper installation can lead to air infiltration, moisture and poor overall product performance. Rylock has comprehensive typical building-in detail for four common wall types to assist installers:

- Lightweight Cladding | Linea Board
- Lightweight Cladding | Hebel PowerPanel
- Brick Veneer; and
- Double Brick

[View the Commercial Series Awning Window Installation Guide](#)

### SCAN QR CODE FOR INSTALLATION GUIDE

Technical Resources on this page include:

- 3D Interactive Renders
- Typical Building-In Detail CAD Drawings
- Link to the NCC (requires login)
- AGWA Fixing Guide (PDF download)

